



Instruction Manual

ZCV116MC, ZCV128MC

 **INFLAMMABLE REFRIGERANT GAS** 

DO NOT use mechanical devices to defrost refrigerator. DO NOT puncture refrigerant tubing.

DANGER - Risk of fire or explosion. Inflammable refrigerant used. To be repaired only by trained service personnel.

All safety precautions must be followed.

CAUTION - Risk of fire or explosion. Dispose of property in accordance with federal or local regulations.

CAUTION - Risk of fire or explosion. Follow handling instructions carefully. Inflammable refrigerant used.

It is advisable to make a note of the model number and the serial number of the appliance before installing the appliance.

Model number

Serial number

Date of purchase

This Instruction Manual contains important information, including safety & installation details, which will enable you to appropriately use your appliance.

IMPORTANT: A&P Electronic Trading Company Limited declines all responsibility in the event of the installer failing to observe all the accident prevention regulations in force, which are necessary for normal use and the regular operation of the electric system.



IMPORTANT SAFETY INFORMATION

Before the appliance is used, it must be properly positioned and installed as described in this manual, so read the manual carefully. To reduce the risk of fire, electrical shock or injury when using the appliance, follow basic precaution, including the following:

- Plug into a grounded 3-prong outlet, do not remove grounding prong, do not use an adapter, and do not use an extension cord. It is recommended to use a separate circuit, serving only your appliance.
- Never clean appliance parts with inflammable fluids. Never store or let gasoline or other inflammable vapours and liquids near this appliance.
- Before proceeding with cleaning and maintenance operations, make sure the power of the unit is disconnected. Failure to do so can result in electrical shock or death.
- Do not connect or disconnect the electric plug when your hands are wet.
- All repair servicing should be referred to a qualified technician.
- Use two or more people to move and install appliance. Failure to do so can result in back or other injury.
- To ensure proper ventilation for your appliance, the front of the unit must be completely unobstructed. Choose a well-ventilated area with temperatures above 16°C (60°F) and below 32°C (90°F). This unit must be installed in an area protected from the element, such as wind, rain, water spray or drips.
- The appliance should not be located next to ovens, grills or other sources of high heat.
- The appliance must be installed with all electrical, water and drain connections in accordance with ordinances required.
- Do not kink or pinch the power supply cord of appliance. Never unplug the appliance by pulling the power cord. Always grip the plug firmly and pull straight out from the receptacle. Repair or replace immediately all power cords that have become frayed or otherwise damaged. Do not use a cord that shows cracks or abrasion damage along its length or at either end. When moving the appliance, be careful not to damage the power cord.
- The fuse (or circuit breaker) size should be 13 amperes.
- It is important for the appliance to be levelled in order to work properly. You may need to make several adjustments to level it.
- Risk of child entrapment. Junked or abandoned appliances are still dangerous. Before you throw away your old wine cellar, take off the door but leave the shelves in place so that children may not easily climb inside. Never allow children to operate, play with or crawl inside the appliance.
- Do not use solvent-based cleaning agents or abrasives on the interior. These cleaners may damage or discolour the interior.
- Do not use this apparatus for other than its intended purpose.



INSTALLATION INSTRUCTIONS

Before using your wine cellar

- Remove the exterior and interior packing by two or more people.
- Check to be sure you have all of the following parts:
 - Local Warranty Card
 - Instruction Manual
- Before connecting the Wine Cellar to the power source, let it stand upright for approximately 2 hours. This will reduce the possibility of a malfunction in the cooling system from handling during transportation.
- Clean the interior surface with lukewarm water using a soft cloth.

Installation of your wine cellar

- This appliance is designed to be for free standing installation or built-in.
- Place your wine cellar on a floor that is strong enough to support it when it is fully loaded. To level your wine cellar, adjust the front levelling legs at the bottom of the wine cellar.
- The standard shelves are designed for Bordeaux bottle storage. The maximum loading capacity may vary subject to the different size or dimension of the wine bottles you store, as well as the shelves quantity pre-installed in the wine cooler.
- To prevent damaging the door and the door gasket, make sure to have the door open fully all the way before pulling out the shelves. **Please be careful and pull softly to avoid dropping of bottles.**
- Should the wine cooler be left empty for a long period please unplug and clean the appliance, then leave the door ajar to allow air to circulate inside the cabinet in order to avoid condensation, mold or odours forming.
- Locate the wine cellar away from direct sunlight and sources of heat (stove, heater, radiator, etc.). Direct sunlight may affect the acrylic coating and heat sources will increase electrical consumption.
- Extreme cold ambient temperatures may also cause the unit not to perform properly. **When the ambient (room) temperature is below 5°C, please unplug the cellar to avoid freezing the wine.**
- Avoid locating the unit in moist areas.
- The appliance should always be plugged into its own individual electrical outlet which has a voltage rating that matches the rating label on the appliance.
- If the appliance is going to be used in an area or if your city / country is prone to power surges / outages; it is suggested that you use a power surge protector for all electrical devices / appliances you use. The surge protector that you select must have a surge block high enough to protect the appliance it is connected to. If you have any questions regarding the type and size of surge protector needed contact a licensed electrician in your area. Damages due to power surges are not considered a manufacturer covered defect and will void your product warranty.

OPERATING YOUR WINE CELLAR









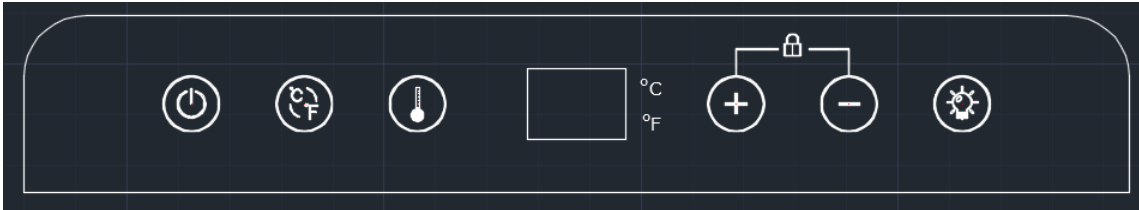





It is recommended you install the wine cellar in a place where the ambient temperature is between 19°C-24°C (66°F-75°F), and humidity is under 60%. If the ambient temperature is above or below recommended temperatures, the performance of the unit may be affected. Placing your unit in extreme cold or hot conditions may cause interior temperatures to fluctuate. The range of 5°C-18°C (40°F-65°F) may not be reached.

*Temperature °C may varies between $\leq \pm 2$ °C

Control Panel and Setting



- Power switch : After the unit is power on, press  for 3 seconds to turn on or off the unit.
- °C/°F switch: Press  button to change the temperature display between Celsius and Fahrenheit.
- Temperature setting button : Press  before adjust temperature. When press it first time, the display flashes and shows the setting temperature. After 5 seconds it shows the measured interior temperature. Press  to increase the setting temperature and press  to decrease the setting temperature.
- Display window: 2-digit LED display to show setting temperature or actual interior temperature.
- Light button : Press  to turn on or off. When open door, the light will be switched on automatically. To keep the light stay on for 10 mins, please turn the light off first after opening the door and then press  for 5 seconds to set it.
- Key lock function: If there is no any operation with digital control for 3 minutes, it will be locked automatically. Press  and  in the same time for 3 seconds to unlock.

NOTE: If the unit is unplugged, if the power is lost, or turned off, you must wait 3 to 5 minutes before restarting the unit. If you attempt to restart before this time delay, the wine cellar will not start.

Shelves

- To prevent damaging the door gasket, make sure to have the door all the way opened when pulling shelves out of the rail compartment.
- For easy access to the storage content, you must pull the shelves approximately 1/3 out of the rail compartment, however this unit was designed with a notch on each side of the shelf tracks to prevent bottles from falling.

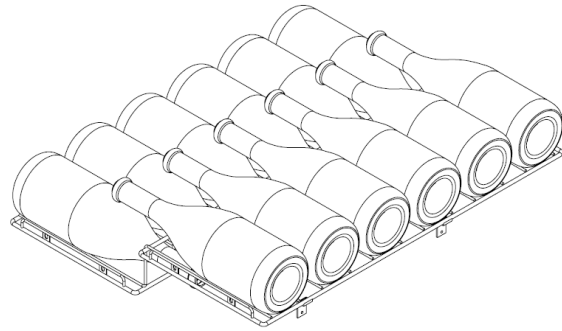
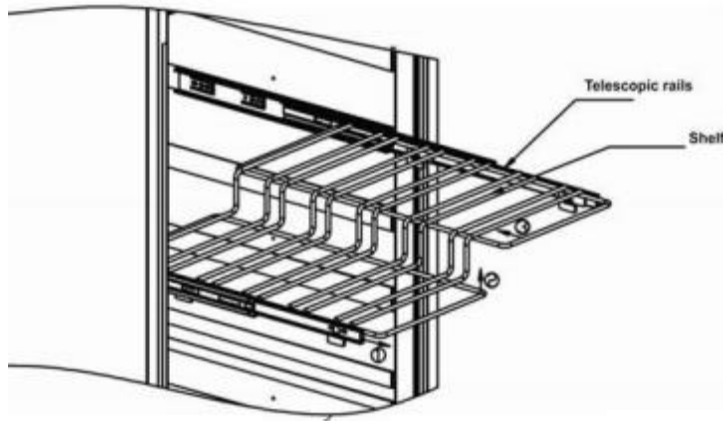

Cleaning your wine cellar

Turn off and unplug the appliance, and remove all items including shelves. Wash the inside surfaces with a warm water and baking soda solution. The solution should be about 2 tablespoons of baking soda to 1 cup of water. Wash the shelves with a mild detergent solution. Wash the outside cabinet with warm water and mild liquid detergent. Rinse well and wipe dry with a clean soft cloth. Do not use steel wool or steel brush on the stainless steel. These will contaminate the stainless steel with steel particles and rusting may occur.

Correct Disposal of this product

Before disposal of the appliance.

1. Disconnect the main plug from the main socket.
2. Cut off the main cable and discard it.

To prevent possible harm to the environment or human health from uncontrolled waste disposal, recycle it responsibly to promote the sustainable reuse of material resources. To return your used device, please use the return and collection systems or contact the retailer where the product was purchased. They can take this product for environmental safe recycling.



TROUBLESHOOTING GUIDE

You can solve many common wine cellar problems easily, saving you the cost of a possible service call. Try the suggestions below to see if you can solve the problem before calling the servicer.

PROBLEM	POSSIBLE CAUSE	SOLUTION
Cellar does not operate.	<p>Not plugged in.</p> <p>The appliance is turned off.</p> <p>The circuit breaker tripped or a blown fuse.</p>	<p>Plug the unit.</p> <p>Press  to turn on the unit.</p> <p>Check the breaker and/or fuses.</p>
Cellar is not cold enough.	<p>External environment may require a higher setting.</p> <p>The door is opened too often.</p> <p>The door is not closed completely.</p> <p>The door gasket does not seal properly.</p>	<p>Check the temperature control setting.</p> <p>Close the door properly.</p> <p>Check the door gasket.</p>
The compressor turns on and off frequently.	<p>The room temperature is hotter than normal.</p> <p>A large amount of contents has been added to the cellar.</p> <p>The door is opened too often.</p> <p>The door is not closed completely.</p> <p>The temperature control is not set correctly.</p> <p>The door gasket does not seal properly.</p>	<p>Close the door properly.</p> <p>Check the door gasket.</p>
The fans turn on and off frequently.	<p>In order to circulate the air and maintain the set temperature inside the cabinet the fans must cycle on and off even when the compressor is off. The fans will cycle ON and OFF while the compressor is off approximately every 10 seconds, this is called "Semi-speed status". This cycle is normal and meant both to circulate the air as well as ensure the continued operational status of the fans. If the fan stops completely and does not complete this cycle the fan is non-operational.</p>	
The light does not work.	<p>Not plugged in.</p> <p>The circuit breaker tripped or a blown fuse.</p> <p>The light button is "OFF".</p>	<p>Plug the unit.</p> <p>Check the breaker and/or fuses.</p>

Vibrations.	<p>The cellar is not levelled</p> <p>The bottles are vibrating.</p> <p>There is an object under the cellar.</p>	<p>Check to assure that the cellar is level.</p> <p>Make sure the bottles don't touch each others.</p> <p>Remove the object.</p>
The cellar seems to make too much noise.	The cellar is not level.	<p>Level the cellar.</p> <p>The rattling noise may come from the flow of the refrigerant, which is normal. As each cycle ends, you may hear gurgling sounds caused by the flow of refrigerant in your cellar. Contraction and expansion of the inside walls may cause popping and crackling noises.</p>
The door will not close properly.	<p>The cellar is not level.</p> <p>The door was reversed and not properly installed.</p> <p>The gasket is dirty.</p> <p>The shelves are out of position.</p>	<p>Level the cellar.</p> <p>Close the door properly.</p> <p>Clean the door gasket.</p> <p>Place the shelves properly.</p>
<p>Error Code:</p> <p>E1-E2-E3-</p> <p>E4-E7-E8</p>	A sensor has failed.	Contact us for a service call.

NOTICE

- The wine cooler is operated by compressor and the internal temperature is reached by the circulation of the refrigerant in the pipeline. During the cooling process, the fluid of refrigerant may generate some flowing sound. Contraction and expansion of the inside walls may also cause popping and crackling noise. The sound during the circulation is normal.
- Moreover, the start and stop of the operation of compressor may incur buzzing sound. The electrical components may also cause some “clattering” and “boh” sound due to their constant connection or disconnection. All these light sounds are normal. To help minimize them, it is advised to adjust the level of the wine cooler by turning the adjustment leg under the cabinet.